

# PANERA

ISITMA SİSTEMLERİ / HEATING SYSTEMS

ÜRÜN KATALOĞU  
PRODUCT CATALOGUE



[www.panera.com.tr](http://www.panera.com.tr)

 **gufo**  
[www.gufo.com.tr](http://www.gufo.com.tr)

**SİROKKO**  
[www.sirokko.com.tr](http://www.sirokko.com.tr)

 **TRADYANT**  
[www.ctradyant.com.tr](http://www.ctradyant.com.tr)

Katalog/Catalog V01/24



# PANERA

ISITMA SİSTEMLERİ / HEATING SYSTEMS

Yıllar içerisinde biriken bilgi ve edinilen tecrübeler doğrultusunda, öncelikli olarak ülkemizin ithal ürünlere olan ihtiyaçlarını yerli üretimler ile karşılamak, sonrasında yurtdışına yönelik üretim yapmak gayesi ile kurulan firmamız 2015 yılı itibariyle aktif olarak faaliyetlerine ve üretime devam etmektedir.

Panera Mühendislik olarak Isıtma sektöründe yurtdışından ithal getirilen ürünlerin yerine %100 yerli üretim ile ürünlerimizi daha kaliteli ve daha hesaplı bir şekilde piyasaya arz ediyoruz. Isıtma sektöründe kısa zamanda ülkemizin lider üreticilerinden olduk. AR-GE 'ye ve kaliteye çok önem vermekteyiz. Tüketicilerimizin ihtiyaçları doğrultusunda ürünler geliştirerek müşteri memnuniyetini daima tüm çıkarlarımızın üstünde tutmaktayız.

In line with the accumulated knowledge and experience gained over the years, our company was established primarily with the purpose of meeting the needs of our country for imported products with domestic productions and then with the aim of producing for abroad, as of 2015, it continues its activities and production actively.

As Panera Engineering, we supply quality and more cost-effectively with 100% domestic production instead of imported products in the heating sector. We have become one of the leading manufacturers in the heating sector in a short time. We attach great importance to R & D and quality. By developing products in line with the needs of our consumers, we always keep customer satisfaction above all our interests.



# PANERA

ISITMA SİSTEMLERİ / HEATING SYSTEMS



02

HG	.....	2-3
NG	.....	4-5
GT	.....	6-7
NEO	.....	8-9
E2/E4	.....	10
E18	.....	11
ECO-L/LD	.....	12-13
ECO-D	.....	14
GP	.....	15



16

CTP U/L	.....	16-17
---------	-------	-------



18

Sirokko E	.....	18-19
Nano	.....	20-21
20-30-40	.....	22-23
SU 30-SU40	.....	22-23
50-60-70	.....	24-25
Farm	.....	26-27
Air Wall	.....	28

Panera Mühendislik Makina bilgilendirme gereksinimi duymadan istediği zaman katalogdaki ürünler üzerinde değişiklik ve düzeltme yapma hakkını saklı tutar.

PANERA Engineering reserves innovation and revision rights on products specified in the catalogue without notifying them.

**gufo**® **HG** Seramik Plakalı  
Radyant Isıtıcı  
■ Ceramic Plate Radiant Heater

Otel, restoran, cafe ve ofislerin kış bahçelerinde, teraslarında, sigara içim alanlarına özel doğal gazlı, ekonomik ısıtma aracı olarak şık kullanım sunmaktadır.

Gufo HG gas fired heater is designed as an economic heating solution with its stylish design to be used in the winter gardens of restaurants, cafes, hotels and offices, smoking areas and terraces.

 **Cihaz/Device** : gufo

 **Model/Model** : HG

 **Yakıt Tipi/Fuel Type** : Doğalgaz, LPG/NLG, LPG



**Özel Seramik Plaka**

Yüksek yanma ve ışıma sahip Alman malı (**Schwank**) seramik plakalar ile maksimum verim.

**Special Ceramic Plate**

Maximum performance with German ceramic (**Schwank**) plates with high combustion and radiation.



**Uzaktan Kumanda**

Dahili olarak sunulan uzaktan kumanda ile rahat ve kolay kullanım.

**Remote Controller**

Built-in remote control for convenient and easy operation.



**Güvenlik**

**Honeywell** ateşleme kartı ve gaz valfi takım olarak kullanılmıştır.

**Safety**

**Honeywell** ignition card and gas valve are used as a set.



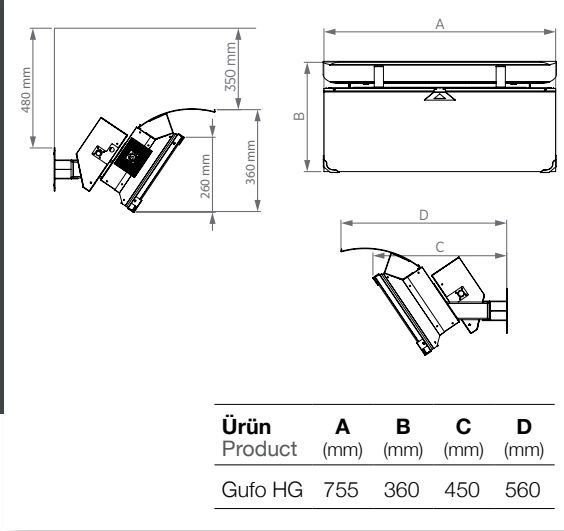

Ürün Product	A (mm)	B (mm)	C (mm)	D (mm)
Gufo HG	755	360	450	560



### Çift Kademeli Yakma Sistemi

Düşük veya yüksek kademeli yakma sistemi ile havanın sıcaklığına göre istenilen sıcaklık konforu rahatlıkla sağlanabilir.

### Two-stage burning system

With the low or high-step burning system, the desired temperature comfort can be provided easily according to the temperature of the air.

## Teknik Özellikler / Technical Features

Ürün Kodu Product Code	1. Kademe Gücü 1 <sup>st</sup> Step Power	2. Kademe Gücü 2 <sup>nd</sup> Step Power	Isıtacağı Alan Heating Area	Doğalgaz Tüketimi Natural Gas Consumption	Tavsiye Edilen Asma Yüksekliği** (H) Recommended Hanging Height** (H)	Doğalgaz Basıncı Natural Gas Pressure	Gaz Bağlantı Çapı Gas Connector Diameter	Elektrik Voltajı Electric Voltage
Gufo HG	7 kW	12,5 kW	25-50 m <sup>2</sup>	1,3 m <sup>3</sup> /saat	2,2 m	20-55 mbar	1/2"	220-240 V

\*Tablo değerleri yaklaşık değerlerdir. Ortamın durumuna göre (kapalı alan, izolasyon, hava akımı v.s.) değişiklik gösterebilir.

\*\*Tavsiye edilen emniyet mesafeleri, PANERA kontrolünde mekanın ihtiyaç ve konumuna göre değişebilir.

\*Table values are approximate. They might be variable according to atmospheric conditions like indoor space, isolation and airflow.

\*\*Recommended safe distance might be changed according to space conditions and location under the supervision of PANERA



# gufo® NG

Seramik Plakalı  
Radyant Isıtıcı  
■ Ceramic Plate Radiant Heater

Restaurant, cafe, otel ve ofislerin kış bahçelerinde, sigara içme alanlarında, teraslarda doğal gazlı ekonomik ısıtma amaçlı olarak kullanılmaktadır.

Gufo NG gas fired heater is designed as an economic heating solution to be used in the winter gardens of restaurants, cafes, hotels and offices, smoking areas and terraces.

 Cihaz/Device : gufo

 Model/Model : NG

 Yakıt Tipi/Fuel Type : Doğalgaz, LPG/NLG, LPG



### Özel Seramik Plaka

Yüksek yanma ve ışıma sahip Alman malı (**Schwank**) seramik plakalar ile maksimum verim.

### Special Ceramic Plate

Maximum performance with German ceramic (**Schwank**) plates with high combustion and radiation.



### Uzaktan Kumanda

Dahili olarak sunulan uzaktan kumanda ile rahat ve kolay kullanım.

### Remote Controller

Built-in remote control for convenient and easy operation.



### Güvenlik

**Honeywell** ateşleme kartı ve gaz valfi takım olarak kullanılmıştır.

### Safety

**Honeywell** ignition card and gas valve are used as a set.



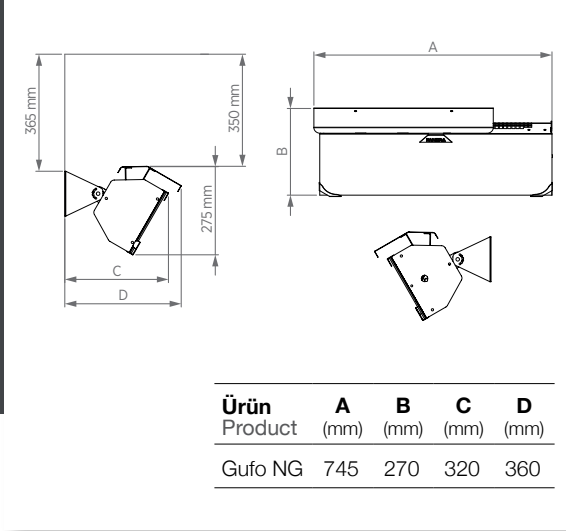

### Çift Kademeli Yakma Sistemi

Düşük veya yüksek kademeli yakma sistemi ile havanın sıcaklığına göre istenilen sıcaklık konforu rahatlıkla sağlanabilir.

### Two-stage burning system

With the low or high-step burning system, the desired temperature comfort can be provided easily according to the temperature of the air.

## Teknik Özellikler / Technical Features

Ürün Kodu Product Code	1. Kademe Gücü 1 <sup>st</sup> Step Power	2. Kademe Gücü 2 <sup>nd</sup> Step Power	Isıtacağı Alan Heating Area	Doğalgaz Tüketimi Natural Gas Consumption	Tavsiye Edilen Asma Yüksekliği** (H) Recommended Hanging Height** (H)	Doğalgaz Basıncı Natural Gas Pressure	Gaz Bağlantı Çapı Gas Connector Diameter	Elektrik Voltajı Electric Voltage
<b>Gufo NG</b>	<b>6,3 kW</b>	<b>11,4 kW</b>	<b>25-50 m<sup>2</sup></b>	<b>1,2 m<sup>3</sup>/saat</b>	<b>2,5 m</b>	<b>20-55 mbar</b>	<b>1/2"</b>	<b>220-240 V</b>

\*Tablo değerleri yaklaşık değerlerdir. Ortamın durumuna göre (kapalı alan, izolasyon, hava akımı v.s.) değişiklik gösterebilir.

\*\*Tavsiye edilen emniyet mesafeleri, PANERA kontrolünde mekanın ihtiyacı ve konumuna göre değişebilir.

\*Table values are approximate. They might be variable according to atmospheric conditions like indoor space, isolation and airflow.

\*\*Recommended safe distance might be changed according to space conditions and location under the supervision of PANERA



# gufo® GT

## Seramik Plakalı Radyant Isıtıcı

■ Ceramic Plate Radiant Heater

Isıtma verimini yüksek noktalara ulaştırarak asimetrik tasarımı ile özellikle tenteler ve şemsiyeler için uygun olan Gufo GT, yüksek ısıtım kapasitesiyle doğal gazlı ekonomik ısıtma sağlar. Asma yüksekliği sınırlı mekanlar için düşük kapasiteli ve hafif olarak tasarlanmıştır.

Gufo GT is especially suitable for awnings and parasols with its asymmetric design that increases heating efficiency to high points. It is designed as low capacity and lightweight for spaces with limited hanging height.

 Cihaz/Device : gufo

 Model/Model : GT

 Yakıt Tipi/Fuel Type : Doğalgaz, LPG/NLG, LPG



### Özel Seramik Plaka

Yüksek yanma ve ısıtımına sahip Alman malı (**Schwank**) seramik plakalar ile maksimum verim.

### Special Ceramic Plate

Maximum performance with German ceramic (**Schwank**) plates with high combustion and radiation.



### Uzaktan Kumanda

Opsiyonel olarak sunulan uzaktan kumanda ile rahat ve kolay kullanım.

### Remote Controller

Comfortable and easy operation with the optional remote control.



### Güvenlik

**Honeywell** ateşleme kartı ve gaz valfi takım olarak kullanılmıştır.

### Safety

**Honeywell** ignition card and gas valve are used as a set.



Özel askı aparatı sayesinde tavana ve duvara montaj edilebilir.  
It can be mounted on the ceiling and wall thanks to its special hanger.



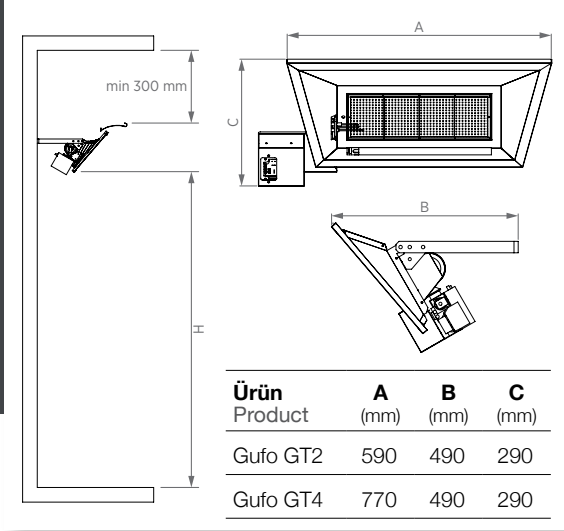
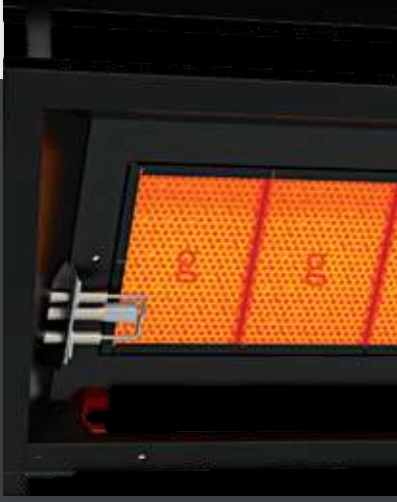

1 2

### Çift Kademeli Yakma Sistemi

Opsiyonel olarak sunulan düşük veya yüksek kademeli yakma sistemi ile havanın sıcaklığına göre istenilen sıcaklık konforu rahatlıkla sağlanabilir.

### Two-stage burning system

With the optional low or high-stage combustion system, the desired temperature comfort can be easily provided according to the temperature of the air.

### Teknik Özellikler / Technical Features

Ürün Kodu Product Code	1. Kademe Gücü 1 <sup>st</sup> Step Power	2. Kademe Gücü 2 <sup>nd</sup> Step Power	Isıtacağı Alan Heating Area	Doğalgaz Tüketimi Natural Gas Consumption	Tavsiye Edilen Asma Yüksekliği** (H) Recommended Hanging Height** (H)	Doğalgaz Basıncı Natural Gas Pressure	Gaz Bağlantı Çapı Gas Connector Diameter	Elektrik Voltajı Electric Voltage
<b>Gufo GT 2</b>	<b>2 kW</b>	<b>4 kW</b>	<b>2-8 m<sup>2</sup></b>	<b>0,42 m<sup>3</sup>/saat</b>	<b>2,0 m</b>	<b>20-55 mbar</b>	<b>1/2"</b>	<b>220-240 V</b>
<b>Gufo GT 4</b>	<b>4 kW</b>	<b>8 kW</b>	<b>8-16 m<sup>2</sup></b>	<b>0,84 m<sup>3</sup>/saat</b>	<b>2,1 m</b>	<b>20-55 mbar</b>	<b>1/2"</b>	<b>220-240 V</b>

\*Tablo değerleri yaklaşık değerlerdir. Ortamın durumuna göre (kapalı alan, izolasyon, hava akımı v.s.) değişiklik gösterebilir.

\*\*Tavsiye edilen emniyet mesafeleri, PANERA kontrolünde mekanın ihtiyaç ve konumuna göre değişebilir.

\*Table values are approximate. They might be variable according to atmospheric conditions like indoor space, isolation and airflow.

\*\* Recommended safe distance might be changed according to space conditions and location under the supervision of PANERA

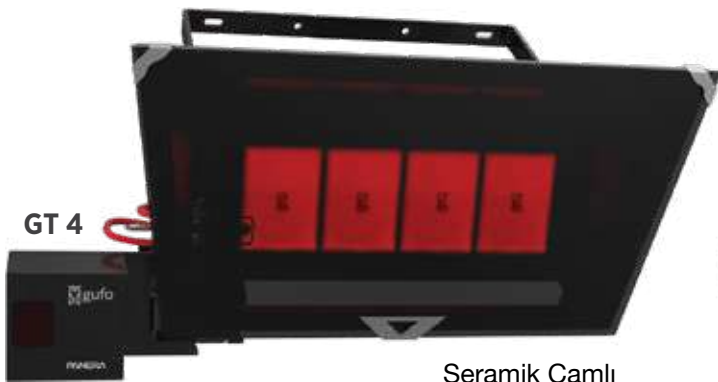

Seramik Camlı  
With Glass





# NEO

Seramik Plakalı  
Radyant Isıtıcı

■ Ceramic Plate Radiant Heater

Otel, restoran, cafe ve ofislerin kış bahçelerinde, teraslarında, sigara içim alanlarına özel doğal gazlı, ekonomik ısıtma aracı olarak şık kullanım sunmaktadır.

Gufo NEO gas fired heater is designed as an economic heating solution to be used in the winter gardens of restaurants, cafes, hotels and offices, smoking areas and terraces.

 Cihaz/Device : gufo

 Model/Model : NEO

 Yakıt Tipi/Fuel Type : Doğalgaz, LPG/NLG, LPG

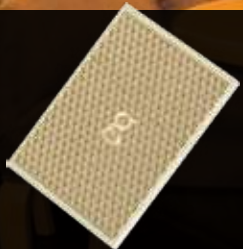

### Özel Seramik Plaka

Yüksek yanma ve ışıma sahip Alman malı (**Schwank**) seramik plakalar ile maksimum verim.

### Special Ceramic Plate

Maximum performance with German ceramic (**Schwank**) plates with high combustion and radiation.



### Uzaktan Kumanda

Dahili olarak sunulan uzaktan kumanda ile rahat ve kolay kullanım.

### Remote Controller

Built-in remote control for convenient and easy operation.



### Güvenlik

**Honeywell** ateşleme kartı ve gaz valfi takım olarak kullanılmıştır.

### Safety

**Honeywell** ignition card and gas valve are used as a set.

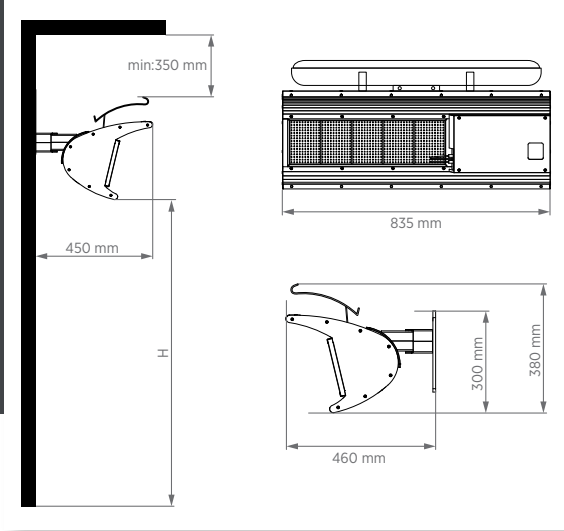

1 2

### Çift Kademeli Yakma Sistemi

Düşük veya yüksek kademeli yakma sistemi ile havanın sıcaklığına göre istenilen sıcaklık konforu rahatlıkla sağlanabilir.

### Two-stage burning system

With the low or high-step burning system, the desired temperature comfort can be provided easily according to the temperature of the air.

## Teknik Özellikler / Technical Features

Ürün Kodu Product Code	1. Kademeli Gücü 1 <sup>st</sup> Step Power	2. Kademeli Gücü 2 <sup>nd</sup> Step Power	Isıtacağı Alan Heating Area	Doğalgaz Tüketimi Natural Gas Consumption	Tavsiye Edilen Asma Yüksekliği** (H) Recommended Hanging Height** (H)	Doğalgaz Basıncı Natural Gas Pressure	Gas Bağlantı Çapı Gas Connector Diameter	Elektrik Voltajı Electric Voltage
Gufo NEO	6,3 kW	11,4 kW	20-50 m <sup>2</sup>	1,2 m <sup>3</sup> /saat	2,2 m	20-55 mbar	1/2"	220-240 V

\*Tablo değerleri yaklaşık değerlerdir. Ortamın durumuna göre (kapalı alan, izolasyon, hava akımı v.s.) değişiklik gösterebilir.

\*\*Tavsiye edilen emniyet mesafeleri, PANERA kontrolünde mekanın ihtiyaç ve konumuna göre değişebilir.

\*Table values are approximate. They might be variable according to atmospheric conditions like indoor space, isolation and airflow.

\*\*Recommended safe distance might be changed according to space conditions and location under the supervision of PANERA



# gufo® e

Kısa Dalga  
Infrared Isıtıcı  
■ Short Wave Infrared Heater

Cafe, restoran, teraslar, kış bahçeleri, sigara içme alanları gibi açık alanlarda ısınma sağlamak için geliştirilmiş etkin, güvenli ve ekonomik Gufo E Isıtıcıları uygun fiyatlarda kullanıcılara sunulmaktadır.

Efficient, safe and economical Gufo E Heaters which are developed for heating in open areas such as cafes, restaurants, terraces, winter gardens, smoking areas are offered to users at reasonable prices.

⚙️ Cihaz/Device : gufo

📱 Model/Model : E 2 - E 4

⚡ Güç K./Power S. : Elektrik/Electricity

## Kısa Dalga Infrared

Gufo-E kısa dalga infrared teknolojisini kullanır. Bu teknoloji sayesinde diğer infrared ısıtıcılara göre %40 daha fazla verim sağlar.

## Short Wave Infrared

Gufo-E short uses wave infrared technology. Thanks to this technology, it provides 40% more efficiency than other infrared heaters.

## Uzaktan Kumanda

Opsiyonel olarak sunulan uzaktan kumanda ile rahat ve kolay kullanım.

## Remote Controller

Comfortable and easy operation with the optional remote control.

## Çift Kademeli Yakma Sistemi

Opsiyonel olarak sunulan düşük veya yüksek kademeli ısıtma sistemi ile havanın sıcaklığına göre istenilen sıcaklık konforu rahatlıkla sağlanabilir.

## Two-stage burning system

With the optional low or high-stage heating system, the desired temperature comfort can be easily provided according to the temperature of the air.

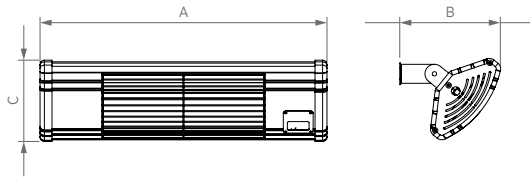

Ürün Product	A	B	C
Gufo E2	530 mm	185 mm	150 mm
Gufo E4	940 mm	185 mm	150 mm

## Teknik Özellikler / Technical Features

Ürün Kodu Product Code	1. Kademe Gücü 1 <sup>st</sup> Step Power	2. Kademe Gücü 2 <sup>nd</sup> Step Power	Akım Power	Elektrik Voltajı Electric Voltage	Ağırlık Weight
Gufo E 2	1.2 kW	2 kW	9.1 A	220-240 V	2,2, kg
Gufo E 4	-	4 kW	13.6 A	220-240 V	2,6 kg

\*Tablo değerleri yaklaşık değerlerdir. \*\*Gufo E2, çift kademeli ve kontrol seçeneği ile sunulmaktadır.

\*Table values are approximate. \*\*Gufo E2 is offered with a double stage and control option.



# gufo® e18

Infrared Isıtıcı  
Infrared Heater

Isı dağılımını en üst düzeye çıkarmak için yüksek yansıtıcı alüminyum reflektör kullanılmıştır. Kolaylık için tasarlanan ısıtma elemanları, dakikalar içinde kolayca değiştirilebilir. Kurulum açısı ayarlanabilir ve 45 dereceye kadar esneklik sağlar.

The reflector is made from highly reflective aluminum to maximize heat distribution. Designed for convenience, the heating elements can be easily replaced within minutes. The installation angle is adjustable, allowing for up to 45 degrees of flexibility.

 Cihaz/Device : gufo

 Model/Model : E 18

 Güç K./Power S. : Elektrik/Electricity

- Fabrikalar, Atölyeler
- Depolar, Hangarlar
- Servis İstasyonları
- Camiler, İbadethaneler
- Çiftlikler
- Açık Alanlar ve diğer tesisler

- Factories, Workplaces
- Warehouses, Hangars
- Service Stations
- Mosques, Sanctuary
- Farms
- Outdoor and other places.



### Uzaktan Kumanda

Opsiyonel olarak sunulan uzaktan kumanda ile rahat ve kolay kullanım.

### Remote Controller

Comfortable and easy operation with the optional remote control.



### Çift Kademeli Yakma Sistemi

Opsiyonel olarak sunulan düşük veya yüksek kademeli ısıtma sistemi ile havanın sıcaklığına göre istenilen sıcaklık konforu rahatlıkla sağlanabilir.

### Two-stage burning system

With the optional low or high-stage heating system, the desired temperature comfort can be easily provided according to the temperature of the air.

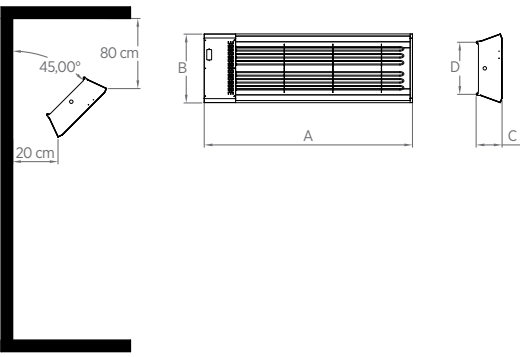

Ürün Product	A	B	C	D
Gufo E18	1800 mm	600 mm	220 mm	450 mm

### Teknik Özellikler / Technical Features

Ürün Kodu Product Code	1. Kademe Gücü 1 <sup>st</sup> Step Power	2. Kademe Gücü 2 <sup>nd</sup> Step Power	Elektrik Besleme Power Supply	Sigorta Circuit Breaker	Kablo Kesiti Cable Cross-Section	Tavsiye Edilen Asma Yüksekliği Recommended Hanging Height	Koruma Sınıfı Protection Class
Gufo E 18	9 kW	18 kW	380 V / 50 Hz	32 A	5x6 mm <sup>2</sup>	5.000 mm	IP42

\*Tablo değerleri yaklaşık değerlerdir. \*\*Gufo E18, çift kademeli ve kontrol seçeneği ile sunulmaktadır.

\*Table values are approximate. \*\*Gufo E18 is offered with a double stage and control option.

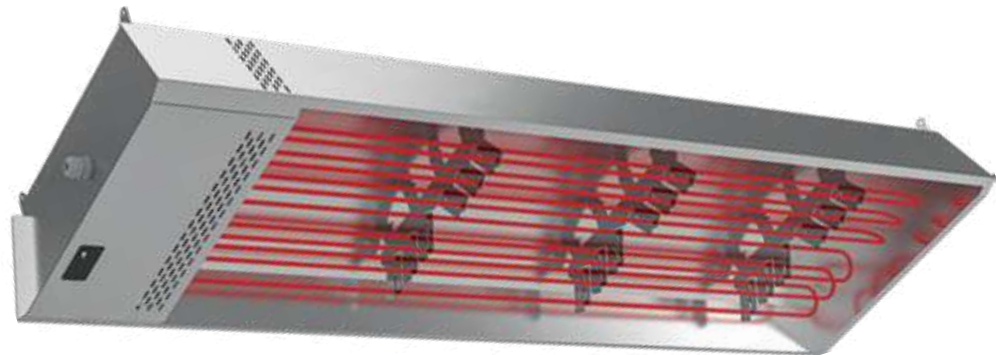



# ECO-L

Seramik Plakalı  
Radyant Isıtıcı

■ Ceramic Plate Radiant Heater

- Fabrikalar, Atölyeler
- Depolar, Hangarlar
- Servis İstasyonları
- Camiler, İbadethaneler
- Çiftlikler
- Açık Alanlar ve diğer tesisler

- Factories, Workplaces
- Warehouses, Hangars
- Service Stations
- Mosques, Sanctuary
- Farms
- Outdoor and other places.

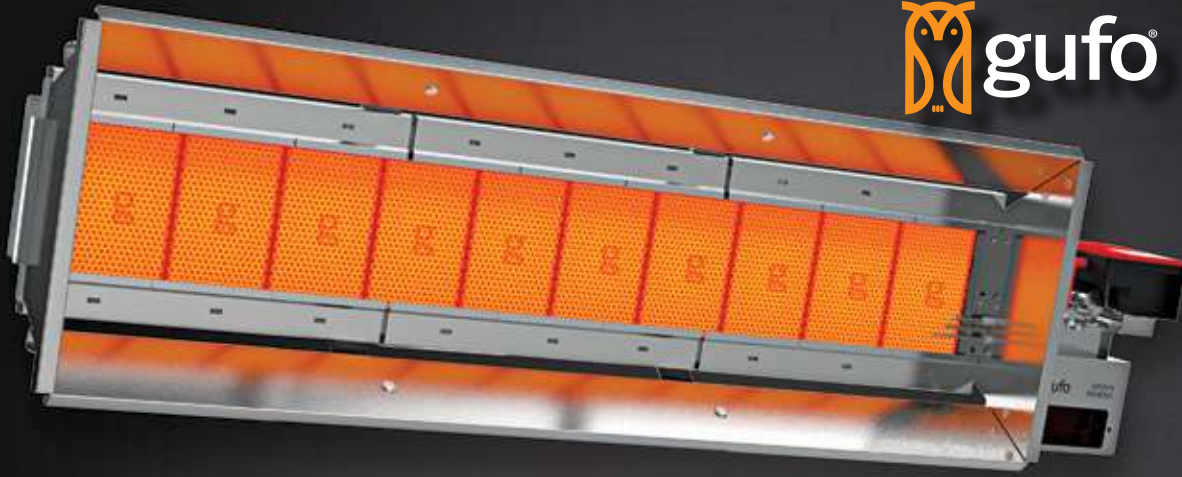

 **Cihaz/Device** : gufo

 **Model/Model** : ECO-L & ECO-LD

 **Yakıt Tipi/Fuel Type**: Doğalgaz, LPG/NLG, LPG

Yüksek ışıma verimi için alüminize yansıtıcılar kullanılmıştır. Güvenliğiniz için arıza durumuna karşı ışıklı ikaz bulunan emniyet sistemi yer almaktadır. Özel bakım programına ihtiyaç duyulmadan uzun yıllar sorunsuz çalışma imkanı verir.

Aluminum reflectors are used for high luminous efficiency. For your safety, there is a safety system with a buzzer against a malfunction. It provides many years of trouble-free operation without the need for special maintenance programs.



ECO-L 5



ECO-L 18



ECO-L 10



ECO-L 14



### Özel Keramik Plaka

Yüksek yanma ve ışıma sahip Alman malı (**Schwank**) seramik plakalar ile maksimum verim.

### Special Ceramic Plate

Maximum performance with German ceramic (**Schwank**) plates with high combustion and radiation.



### Uzaktan Kumanda

Opsiyonel olarak sunulan uzaktan kumanda ile rahat ve kolay kullanım.

### Remote Controller

Comfortable and easy operation with the optional remote control.

### Çift Kademeli Yakma Sistemi

Düşük veya yüksek kademeli yakma sistemi ile havanın sıcaklığına göre istenilen sıcaklık konforu rahatlıkla sağlanabilir.

### Two-stage burning system

With the low or high-step burning system, the desired temperature comfort can be provided easily according to the temperature of the air.

### Opsiyonel WiFi Kontrollü Oda Termostatı

WiFi bağlantısı ile çalışan, programlanabilir, gruplu olarak çoklu çalışmaya uygun yüksek teknoloji termostat.

### Optional WiFi controlled room thermostat

A high-tech thermostat that works with a WiFi connection, is programmable, suitable for multi-tasking in groups.



### Güvenlik

**Honeywell** ateşleme kartı ve gaz valfi takım olarak kullanılmıştır.

### Safety

**Honeywell** ignition card and gas valve are used as a set.

## Teknik Özellikler / Technical Features

Ürün Kodu Product Code	1. Kademe Gücü 1 <sup>st</sup> Step Power	2. Kademe Gücü 2 <sup>nd</sup> Step Power	Doğalgaz Tüketimi Natural Gas Consumption	Tavsiye Edilen Asma Yüksekliği** (H) Recommended Hanging Height** (H)	Doğalgaz Basıncı Natural Gas Pressure	Gaz Bağlantı Çapı Gas Connector Diameter	Elektrik Voltajı Electric Voltage
ECO L5	6 kW	11 kW	1,15 m <sup>3</sup> /saat(h)	2,5 m	20-55 mbar	1/2"	220-240 V
ECO L10	11 kW	18 kW	1,90 m <sup>3</sup> /saat(h)	3,5 m	20-55 mbar	1/2"	220-240 V
ECO L14	16 kW	26 kW	2,73 m <sup>3</sup> /saat(h)	4,5 m	20-55 mbar	1/2"	220-240 V
ECO L18	20 kW	32,1 kW	3,37 m <sup>3</sup> /saat(h)	5,0 m	20-55 mbar	1/2"	220-240 V
ECO LD20	18 kW	36 kW	3,80 m <sup>3</sup> /saat(h)	5,5 m	20-55 mbar	1/2"	220-240 V
ECO LD28	28 kW	52 kW	5,42 m <sup>3</sup> /saat(h)	6,0 m	20-55 mbar	1/2"	220-240 V

\*Tablo değerleri yaklaşık değerlerdir. Ortamın durumuna göre (kapalı alan, izolasyon, hava akımı v.s.) değişiklik gösterebilir.

\*\*Tavsiye edilen emniyet mesafeleri, PANERA kontrolünde mekanın ihtiyacı ve konumuna göre değişebilir.

\*Table values are approximate. They might be variable according to atmospheric conditions like indoor space, isolation and airflow.

\*\*Recommended safe distance might be changed according to space conditions and location under the supervision of PANERA

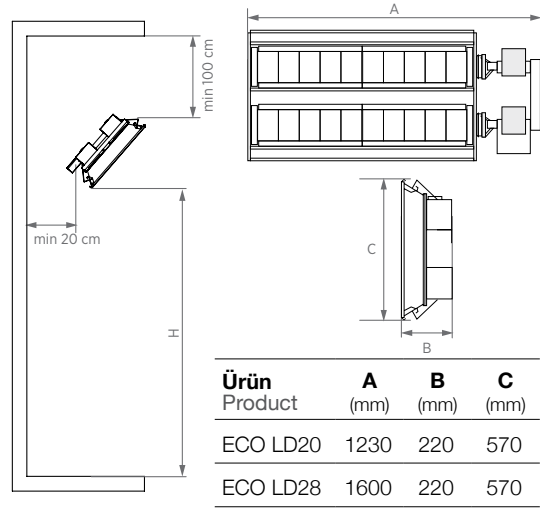
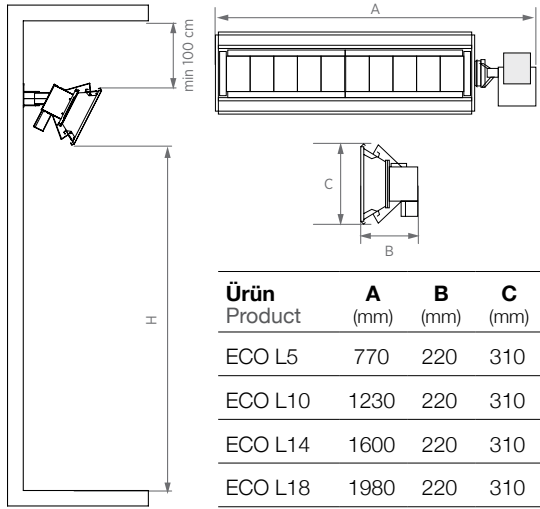

ECO-LD 20





ECO-LD 28

- Fabrikalar
- Hangarlar
- Cafeler
- Restaurantlar
- Seralar
- Atölyeler
- Fuar Alanları
- Showroom'lar
- Spor Salonları
- Depolar
- Servis İstasyonları
- Hayvan Çiftlikleri
- Tenis Kortları
- Açık Alanlar vb.

- Factories
- Hangars
- Cafes
- Restaurants
- Greenhouses
- Workshops
- Fairgrounds
- Showrooms
- Gyms
- Warehouses
- Service Stations
- Animal Farms
- Tennis Courts
- Open Areas

 **Cihaz/Device** : gufo

 **Model/Model** : ECO D

 **Yakıt Tipi/Fuel Type** : Doğalgaz, LPG/NLG, LPG

Yüksek ışımaya verimi için özel tasarım krom yansıtıcılar kullanılmıştır. Güvenliğiniz için arıza durumuna karşı ışıklı ikaz bulunan emniyet sistemi yer almaktadır. Özel bakım programına ihtiyaç duyulmadan uzun yıllar sorunsuz çalışma imkanı verir.

Aluminum reflectors are used for high luminous efficiency. For your safety, there is a safety system with a buzzer against a malfunction. It provides many years of trouble-free operation without the need for special maintenance programs.

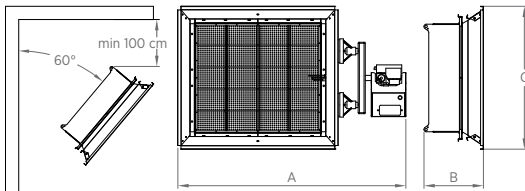

Ürün Product	A (mm)	B (mm)	C (mm)
ECO D9	760	250	440
ECO D12	760	250	530
ECO D12U	900	250	440
ECO D16	900	250	530
ECO D20	900	250	620
ECO D24	900	250	710

ECO-D9



ECO-D12 U



ECO-D12



ECO-D20

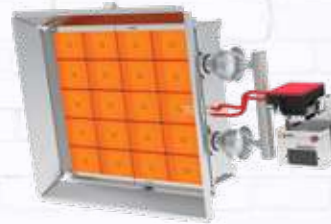

ECO-D24



ECO-D16



## Teknik Özellikler / Technical Features

Ürün Kodu Product Code	1. Kademe Gücü 1 <sup>st</sup> Step Power	2. Kademe Gücü 2 <sup>nd</sup> Step Power	Doğalgaz Tüketimi Natural Gas Consumption	Tavsiye Edilen Asma Yüksekliği** (H) Recommended Hanging Height** (H)	Doğalgaz Basıncı Natural Gas Pressure	Gaz Bağlantı Çapı Gas Connector Diameter	Elektrik Voltajı Electric Voltage
ECO D9	9,8 Kw	16,2 kW	1,5 m <sup>3</sup> /saat(h)	3 m	20-55 mbar	1/2"	220-240 V
ECO D12	13 Kw	21,6 kW	2,2 m <sup>3</sup> /saat(h)	3,5 m	20-55 mbar	1/2"	220-240 V
ECO D16	17,3 Kw	28,8 kW	2,8 m <sup>3</sup> /saat(h)	4 m	20-55 mbar	1/2"	220-240 V
ECO D20	21,6 Kw	36 kW	3,7 m <sup>3</sup> /saat(h)	5 m	20-55 mbar	1/2"	220-240 V
ECO D24	26 Kw	43,2 kW	4,2 m <sup>3</sup> /saat(h)	6 m	20-55 mbar	1/2"	220-240 V

\*Tablo değerleri yaklaşık değerlerdir. Ortamın durumuna göre (kapalı alan, izolasyon, hava akımı v.s.) değişiklik gösterebilir.  
\*\*Tavsiye edilen emniyet mesafeleri, PANERA kontrolünde mekanın ihtiyaç ve konumuna göre değişebilir.

\*Table values are approximate. They might be variable according to atmospheric conditions like indoor space, isolation and airflow.  
\*\* Recommended safe distance might be changed according to space conditions and location under the supervision of PANERA



**Güvenlik**  
Honeywell ateşleme kartı ve gaz valfi takım olarak kullanılmıştır.  
**Safety**  
Honeywell ignition card and gas valve are used as a set.

**Özel Seramik Plaka**  
Yüksek yanma ve ışımaya sahip Alman malı (Schwank) seramik plakalar ile maksimum verim.

**Uzaktan Kumanda**  
Opsiyonel olarak sunulan uzaktan kumanda ile rahat ve kolay kullanım.

**Special Ceramic Plate**  
Maximum performance with German ceramic (Schwank) plates with high combustion and radiation.

**Remote Controller**  
Comfortable and easy operation with the optional remote control.



- Fabrikalar, Atölyeler
- Depolar, Hangarlar
- Servis İstasyonları
- Camiler, İbadethaneler
- Çiftlikler
- Açık Alanlar ve diğer tesisler

- Factories, Workplaces
- Warehouses, Hangars
- Service Stations
- Mosques, Sanctuary
- Farms
- Outdoor and other places.

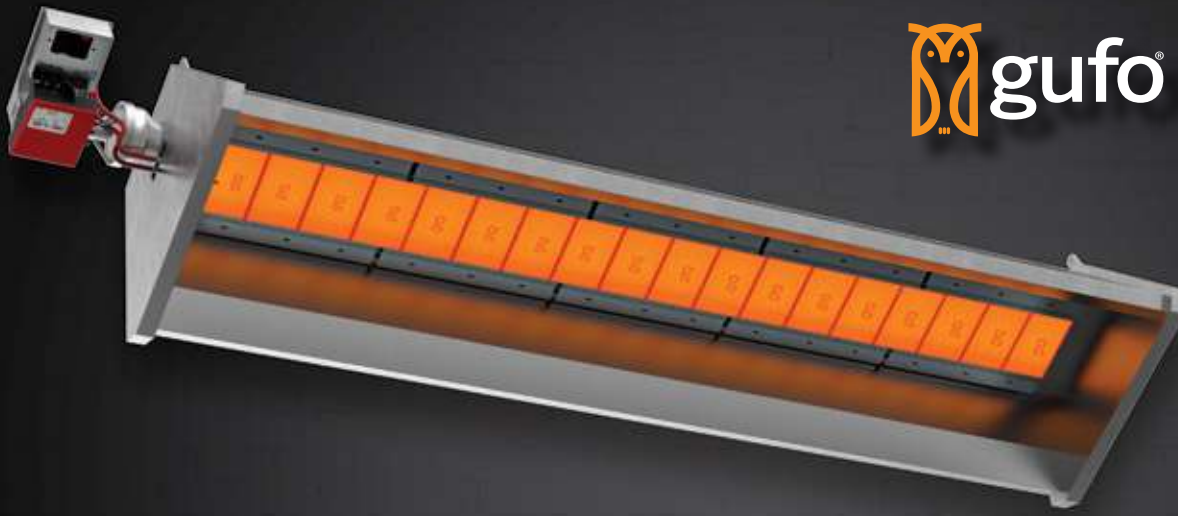

**Cihaz/Device** : gufo

**Model/Model** : GP

**Yakıt Tipi/Fuel Type**: Doğalgaz, LPG/NLG, LPG

En yüksek ışıma verimi ve ısı tasarrufu için özel olarak tasarlanmıştır. Güvenliğiniz için arıza durumuna karşı ışıklı ikaz bulunan emniyet sistemi yer almaktadır. Özel bakım programına ihtiyaç duyulmadan uzun yıllar sorunsuz çalışma imkanı verir.

Gufo GP is specially designed for the highest luminous efficiency and heat saving. For your safety, there is a safety system with a buzzer against a malfunction. It provides many years of trouble-free operation without the need for special maintenance programs.

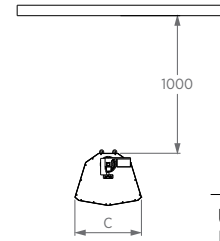
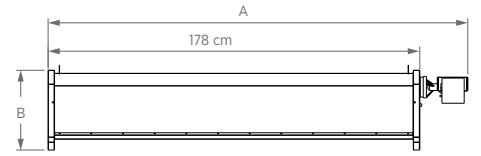
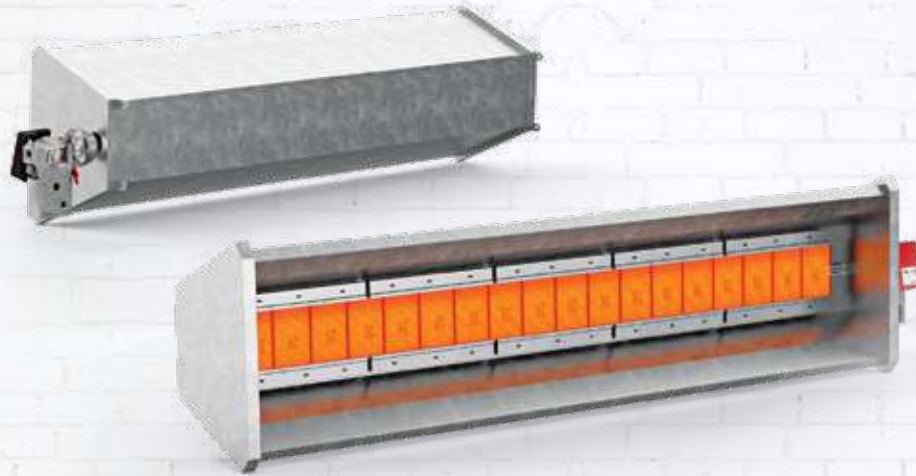

Ürün Product	A (mm)	B (mm)	C (mm)
GP	2000	390	490

### Opsiyonel WiFi Kontrollü Oda Termostatı

WiFi bağlantısı ile çalışan, programlanabilir, gruplu olarak çoklu çalışmaya uygun yüksek teknoloji termostat.

### Optional WiFi controlled room thermostat

A high-tech thermostat that works with a WiFi connection, is programmable, suitable for multi-tasking in groups.

### Çift Kademeli Yakma Sistemi

Düşük veya yüksek kademeli yakma sistemi ile havanın sıcaklığına göre istenilen sıcaklık konforu rahatlıkla sağlanabilir.

### Two-stage burning system

With the low or high-step burning system, the desired temperature comfort can be provided easily according to the temperature of the air.

### Teknik Özellikler / Technical Features

Ürün Kodu Product Code	1. Kademe Gücü 1 <sup>st</sup> Step Power	2. Kademe Gücü 2 <sup>nd</sup> Step Power	Doğalgaz Tüketimi Natural Gas Consumption	Tavsiye Edilen Asma Yüksekliği** (H) Recommended Hanging Height**(H)	Doğalgaz Basıncı Natural Gas Pressure	Gaz Bağlantı Çapı Gas Connector Diameter	Elektrik Voltajı Electric Voltage
<b>Gufo GP</b>	<b>18 kW</b>	<b>34 kW</b>	<b>3,57 m<sup>3</sup>/saat(h)</b>	<b>5 m</b>	<b>20-55 mbar</b>	<b>1/2"</b>	<b>220-240 V</b>
<b>Gufo GP-i</b>	<b>16 kW</b>	<b>30 kW</b>	<b>3,13 m<sup>3</sup>/saat(h)</b>	<b>4,5 m</b>	<b>20-55 mbar</b>	<b>1/2"</b>	<b>220-240 V</b>

\*Tablo değerleri yaklaşık değerlerdir. Ortamın durumuna göre (kapalı alan, izolasyon, hava akımı v.s.) değişkenlik gösterebilir.

\*\*Tavsiye edilen emniyet mesafeleri, PANERA kontrolünde mekanın ihtiyacı ve konumuna göre değişebilir.

\*Table values are approximate. They might be variable according to atmospheric conditions like indoor space, isolation and airflow.

\*\* Recommended safe distance might be changed according to space conditions and location under the supervision of PANERA

## CTP U CTP L . Borulu Radyant Isıtıcı . Tube Heaters

- Fabrikalar
- Hangarlar
- Cafeler
- Restaurantlar
- Seralar
- Atölyeler
- Fuar Alanları
- Showroom'lar
- Spor Salonları
- Depolar
- Servis İstasyonları
- Tenis Kortları
- Açık Alanlar vb.

- Factories
- Hangars
- Cafes
- Restaurants
- Greenhouses
- Workshops
- Fairgrounds
- Showrooms
- Gyms
- Warehouses
- Service Stations
- Tennis Courts
- Open Spaces
- etc.

 **Cihaz/Device** : CT Radyant

 **Model/Model** : CTP U / CTP L

 **Yakıt Tipi/Fuel Type**: Doğalgaz, LPG/NLG, LPG

%92 brülör ve %60-68 ışımaya verimi ile rakiplerinden ayrışır. Yüksek ışımaya verimi için özel tasarım alüminize reflektörler kullanılmıştır. Kullanım kolaylığı için uzaktan kumanda ve çift kademe opsiyonu sunulmaktadır. Projeye göre L/U tipi olarak montaj yapılabilir. Alüminize borular ile özel bakım programına ihtiyaç duyulmadan uzun yıllar sorunsuz çalışma imkanı verir.

It distinguishes itself from its competitors with its 92% burner and 60-68% luminous efficiency. Aluminized reflectors are used for high luminous efficiency. For ease of use, remote control and double step options are offered. It can be assembled as L /U type according to the project. Aluminized tubes allow long years of trouble-free operation without the need for a special maintenance program.



CTP L

CTP U

## Teknik Özellikler / Technical Features

Model/Model (CTP U)	20 U	30 U	40 U	50 U	60 U	70 U
Cihaz Kapasitesi (Kw) Device Capacity (Kw)	20,3	30,5	40,7	50,1	60,5	69,8
Doğalgaz Tüketimi (Nm <sup>3</sup> /H) Natural Gas Consumption (Nm <sup>3</sup> /H)	2,12	3,18	4,25	5,23	6,31	7,27
Lpg Tüketimi (Kg/H) Lpg Consumption (Kg/H)	1,56	2,35	3,13	3,85	4,65	5,36
Tavsiye Edilen Montaj Yüksekliği (mm) Recommended Mounting Height (mm)	3.400	4.600	4.900	5.400	6.400	6.800
Eksoz/Hava Bağlantısı (mm) Exhaust/Air Connection (mm)	Ø100 (6m uzunluğa kadar) / (Up to 6 m long)					
Elektrik Tüketimi (W) Electricity Consumption (W)	90	90	90	105	105	105
Gaz Giriş Basıncı (Mbar) - Doğalgaz Gas Inlet Pressure (Mbar) - Natural Gas	Min: 20 mbar - Max: 55 mbar					
Gaz Giriş Basıncı (Mbar) - Lpg Gas Inlet Pressure (Mbar) - Lpg	Min: 33 mbar - Max: 55 mbar					
Gaz Bağlantısı Gas Connection	1/2"	1/2"	1/2"	3/4"	3/4"	3/4"
Elektrik Bağlantısı Electrical Connection	230 V / 50 Hz - Monofaze					
Ateşleme ve Kontrol Ignition and Control	Ateşleme ve iyonizasyon elektrodları kontrol paneli tarafından kontrol edilir. The ignition and ionization electrodes are controlled by the control panel.					
Cihaz Uzunluk (Tavsiye Edilen) (m) Device Length (Recommended) (m)	4,5	6	6	9	12	12
Cihaz Ağırlık (kg) Device Weight (kg)	60/82	60/82	85/115	105/150	145/210	155/225
CE Sertifikası CE Certificate	CE - 2422-GAR-7022/07					
Yanma Verimi (Brülör) Combustion Efficiency (Burner)	%92-93					
Işınım Verimi (Reflektör) Radiation Efficiency (Reflector)	%60-68					
Model/Model (CTP L)	20 L	30 L	40 L	50 L	60 L	70 L
Cihaz Kapasitesi (Kw) Device Capacity (Kw)	20,3	30,5	40,7	50,1	60,5	69,8
Doğalgaz Tüketimi (Nm <sup>3</sup> /H) Natural Gas Consumption (Nm <sup>3</sup> /H)	2,12	3,18	4,25	5,23	6,31	7,27
Lpg Tüketimi (Kg/H) Lpg Consumption (Kg/H)	1,56	2,35	3,13	3,85	4,65	5,36
Tavsiye Edilen Montaj Yüksekliği (mm) Recommended Mounting Height (mm)	3.400	3.500	4.900	5.500	6.400	6.800
Eksoz/Hava Bağlantısı (mm) Exhaust/Air Connection (mm)	Ø100 (6m uzunluğa kadar) / (Up to 6 m long)					
Elektrik Tüketimi (W) Electricity Consumption (W)	90	90	90	105	105	105
Gaz Giriş Basıncı (Mbar) - Doğalgaz Gas Inlet Pressure (Mbar) - Natural Gas	Min: 20 mbar - Max: 55 mbar					
Gaz Giriş Basıncı (Mbar) - Lpg Gas Inlet Pressure (Mbar) - Lpg	Min: 33 mbar - Max: 55 mbar					
Gaz Bağlantısı Gas Connection	1/2"	1/2"	1/2"	3/4"	3/4"	3/4"
Elektrik Bağlantısı Electrical Connection	230 V / 50 Hz - Monofaze					
Ateşleme ve Kontrol Ignition and Control	Ateşleme ve iyonizasyon elektrodları kontrol paneli tarafından kontrol edilir. The ignition and ionization electrodes are controlled by the control panel.					
Cihaz Uzunluk (Tavsiye Edilen) (m) Device Length (Recommended) (m)	6	9	12	15	18	21
Cihaz Ağırlık (kg) Device Weight (kg)	60/82	60/82	85/115	105/150	145/210	155/225
CE Sertifikası CE Certificate	CE - 2422-GAR-7022/07					
Yanma Verimi (Brülör) Combustion Efficiency (Burner)	%92-93					
Işınım Verimi (Reflektör) Radiation Efficiency (Reflector)	%60-68					

\*Tablo değerleri yaklaşık değerlerdir. Ortamın durumuna göre (kapalı alan, izolasyon, hava akımı v.s.) değişkenlik gösterebilir.

\*\*Tavsiye edilen emniyet mesafeleri, PANERA kontrolünde mekanın ihtiyaç ve konumuna göre değişebilir.

\*Table values are approximate. They might be variable according to atmospheric conditions like indoor space, isolation and airflow.

\*\* Recommended safe distance might be changed according to space conditions and location under the supervision of PANERA

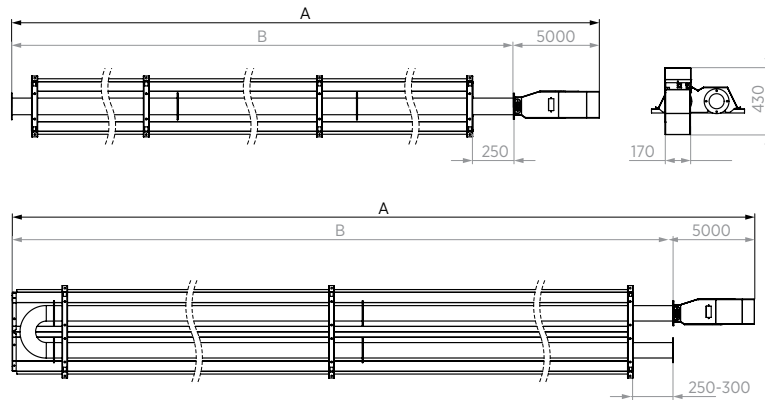

# RADYANT

## CTP U-L

Borulu Radyant Isıtıcı  
Tube Heaters



### Uzaktan Kumanda

Opsiyonel olarak sunulan uzaktan kumanda ile rahat ve kolay kullanım.

### Remote Controller

Comfortable and easy operation with the optional remote control.

### Çift Kademeli Yakma Sistemi

Düşük veya yüksek kademeli yakma sistemi ile havanın sıcaklığına göre istenilen sıcaklık konforu rahatlıkla sağlanabilir.

### Two-stage burning system

With the low or high-step burning system, the desired temperature comfort can be provided easily according to the temperature of the air.

### Opsiyonel WiFi Kontrollü Oda Termostatı

WiFi bağlantısı ile çalışan, programlanabilir, gruplu olarak çoklu çalışmaya uygun yüksek teknoloji termostat.

### Optional WiFi controlled room thermostat

A high-tech thermostat that works with a WiFi connection, is programmable, suitable for multi-tasking in groups.

### Güvenlik

Honeywell ateşleme kartı ve gaz valfi takım olarak kullanılmıştır.

### Safety

Honeywell ignition card and gas valve are used as a set.

# SIROKKO

**E** 20-30-40  
50-60-70

Sıcak Hava Üreteci

Hot Air Generators



- Yüksek verimlidirler
- Montaj ve işletmesi kolaydır
- Uzun ömürlüdür
- Elektronik ateşlemelidir
- Ortamı çok kısa zaman da rejime sokar
- Ekonomiktir
- Yatırım ve işletme maliyetleri kazan ve borulama vs. ihtiyacına göre düşüktür.

- High efficiency
- Easy to assemble and execute
- Long life
- Electronic ignition system
- Homogeneously heat distribution in a short time
- Economic
- Investment and operating costs are lower than heating system with boiler and tubing system

 Cihaz/Device : Sirokko E

 Model/Model : 20-30-40-50-60-70

 Güç K./Power S. : Elektrik/Electricity



## Teknik Özellikler / Technical Features

Model/Model	Birim Unit	E 20	E 30	E 40	E 50	E 60	E 70
Elektrik Gücü Electrical Connection	kW	18	30	36	48	60	72
Elektrik Besleme Power Supply	V	380 V 50 Hz - 3P+N+PE					
Sigorta Circuit Breaker	A	32	50	63	80	100	125
Hava Debisi Air Flow	m <sup>3</sup> /sa	2600	2600	3500	4800	5960	6800
Fan Çapı Fan Diameter	mm	350	350	400	450	350x2	400x2
Gürültü Seviyesi Noise Level	dBA	52	52	53	53	52	53
Kablo Kesiti* Cable Cross-Section	mm <sup>2</sup>	5*6	5*6	5*10	5*16	5*25	5*25
Genişlik (A) Width (A)	mm	750	750	750	780	750	750
Yükseklik (B) Height (B)	mm	550	550	550	550	1000	1000
Derinlik (C) Depth (C)	mm	590	800	800	930	800	800
Isıtıcı Alan Heating Area	m <sup>2</sup>	60-120	80-150	150-225	200-400	250-500	325-650

\*Kablo kesitleri maksimum 50 m uzunluğa göre hesaplanmıştır.

\*Cable cross sections are calculated for a maximum length of 50 m.

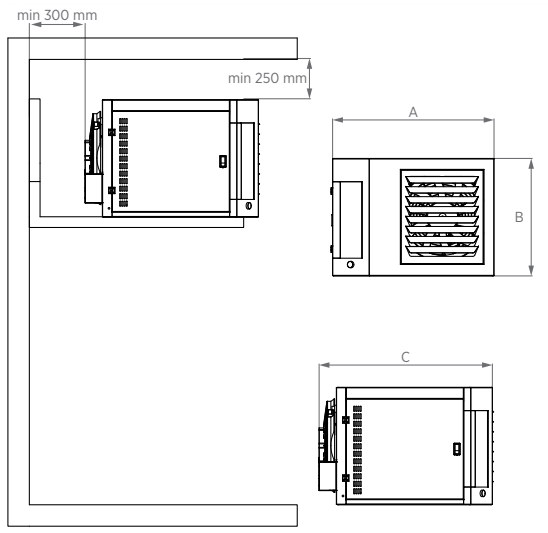

Sirokko E 20-30-40-50



Sirokko E 60-70



# SIROKKO

**E 20-30-40**  
**E 50-60-70**

Sıcak Hava Üreteçleri  
Hot Air Generators



**Opsiyonel Dijital ve Manuel Oda Termostati Seçenekleri**  
Optional Digital and manual room thermostat options



**Uzaktan Kumanda**

Opsiyonel olarak sunulan uzaktan kumanda ile rahat ve kolay kullanım.  
**Remote Controller**

Comfortable and easy operation with the optional remote control.

# SIROKKO nano

Sıcak Hava Üreteci  
■ Hot Air Generator



- Yüksek verimlidirler
- Montaj ve işletmesi kolaydır
- Uzun ömürlüdür
- Elektronik ateşlemelidir
- Ortamı çok kısa zaman da rejime sokar
- Ekonomiktir
- Yatırım ve işletme maliyetleri kazan ve borulama vs. ihtiyacına göre düşüktür.

- High efficiency
- Easy to assemble and execute
- Long life
- Electronic ignition system
- Homogeneously heat distribution in a short time
- Economic
- Investment and operating costs are lower than heating system with boiler and tubing system

- **Cihaz/Device** : Sirokko
- **Model/Model** : nano
- **Yakıt Tipi/Fuel Type** : Doğalgaz, LPG/NLG, LPG

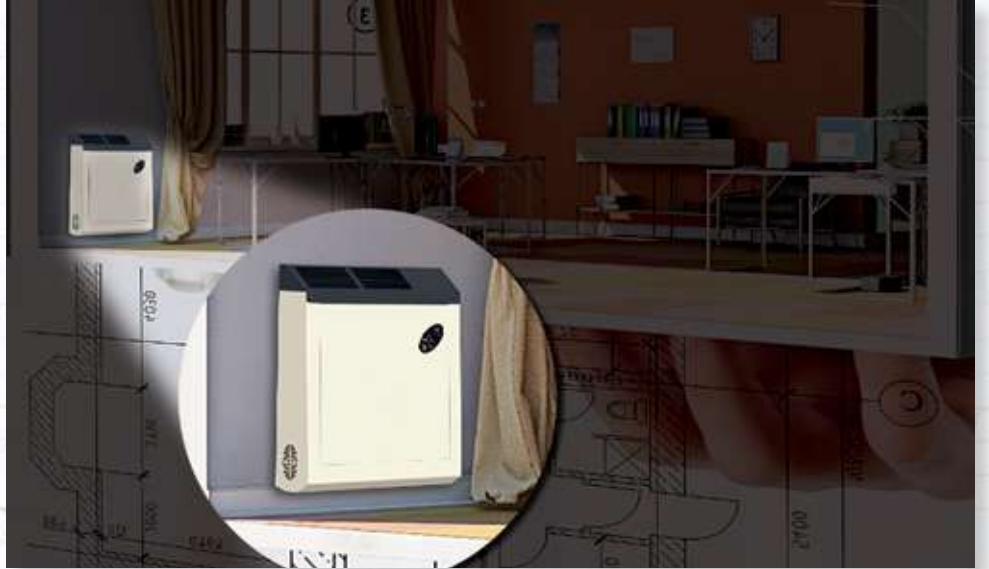

## Teknik Özellikler / Technical Features

Model/Model	Sirokko NANO		
	Birim / Unit	Min.	Max.
Nominal Isıl Güç Nominal Thermal Power	kW	3	6
Çıkış Gücü Output Power	kW	2,7	5,4
Doğalgaz Tüketimi Natural Gas Consumption	Nm <sup>3</sup> /sa	0,28	0,56
Gaz Bağlantısı Gas Connection	inch	1/2"	
Giriş Basıncı Inlet Pressure	mbar	Doğalgaz/LNG (max: 55 / min: 20) - LPG (max: 55 / min: 30)	
Elektrik Besleme Power Supply	volt	230v, 50Hz	
Hava Debisi Air Flow	m <sup>3</sup> /s	275	
Güç Power	W	170	
Gürültü Seviyesi Noise Level	dBA	40	
Genişlik (A) Width (A)	mm	630	
Yükseklik (B) Height (B)	mm	830	
Derinlik (C) Depth (C)	mm	285	
Ağırlık Weight	kg	37	
Isıtacağı Alan Heating Area	m <sup>2</sup>	25-60	

\*Tablo değerleri yaklaşık değerlerdir. Ortamın durumuna göre (kapalı alan, izolasyon, hava akımı v.s.) değişiklik gösterebilir.

\*\*Tavsiye edilen emniyet mesafeleri, PANERA kontrolünde mekanın ihtiyaç ve konumuna göre değişebilir.

\*Table values are approximate. They might be variable according to atmospheric conditions like indoor space, isolation and airflow.

\*\* Recommended safe distance might be changed according to space conditions and location under the supervision of PANERA



### Modülasyonlu Yakma Sistemi

Düşük veya yüksek kademeyi ortamın sıcaklığına göre otomatik ayarlayarak istenilen sıcaklık konforunu sağlar.

### Modulated Burning System

It provides the desired temperature comfort by automatically adjusting the low or high stage according to the ambient temperature.



### Güvenlik

**Honeywell** ateşleme kartı ve gaz valfi takım olarak kullanılmıştır.

### Safety

**Honeywell** ignition card and gas valve are used as a set.

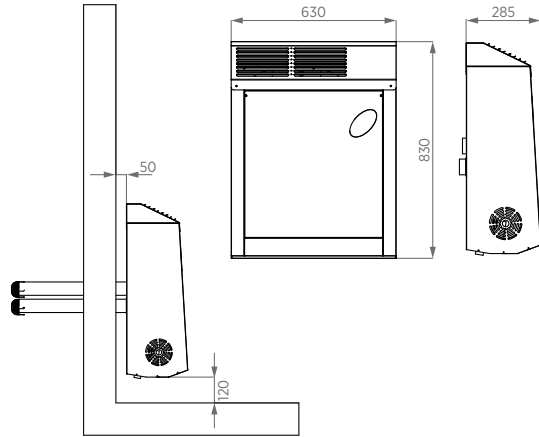

# SİROKKO 20-30-40

Sıcak Hava Üreteçleri

■ Hot Air Generators



- Yüksek verimlidirler
- Montaj ve işletmesi kolaydır
- Uzun ömürlüdür
- Elektronik ateşlemelidir
- Ortamı çok kısa zaman da rejime sokar
- Ekonomiktir
- Yatırım ve işletme maliyetleri kazan ve borulama vs. ihtiyacına göre düşüktür.

- High efficiency
- Ease to assemble and execute
- Long life
- Electronic ignition system
- Homogeneously heat distribution in a short time
- Economic
- Investment and operating costs are lower than heating system with boiler and tubing system

 Cihaz/Device : Sirokko

 Model/Model : 20 - 30 - 40 - SU 30 - SU 40

 Yakıt Tipi/Fuel Type : Doğalgaz, LPG/NLG, LPG



SU 30



## Teknik Özellikler / Technical Features

Model/Model		Sirokko 20	Sirokko 30	Sirokko 40	Sirokko SU 30	Sirokko SU 40
	Birim Unit	1. - 2. Kademe 1 <sup>st</sup> - 2 <sup>nd</sup> Step	1. - 2. Kademe 1 <sup>st</sup> - 2 <sup>nd</sup> Step	1. - 2. Kademe 1 <sup>st</sup> - 2 <sup>nd</sup> Step	1. - 2. Kademe 1 <sup>st</sup> - 2 <sup>nd</sup> Step	1. - 2. Kademe 1 <sup>st</sup> - 2 <sup>nd</sup> Step
Nominal Isıl Güç Nominal Thermal Power	kW	10,4 - 17,3	16,4 - 27,2	22,1 - 36,7	16,4 - 27,2	22,1 - 36,7
Çıkış Gücü Output Power	kW	9,6 - 16	15,1 - 25	20,4 - 34	15,1 - 25	20,4 - 34
Doğalgaz Tüketimi Natural Gas Consumption	Nm <sup>3</sup> /sa	1,1 - 1,81	1,7 - 2,84	2,3 - 3,83	1,7 - 2,84	2,3 - 3,83
Gaz Bağlantısı Gas Connection	inch	1/2"	1/2"	1/2"	1/2"	1/2"
Giriş Basıncı Inlet Pressure	mbar	Doğalgaz/LNG (max: 55 / min: 20) - LPG (max: 55 / min: 30)				
Elektrik Besleme Power Supply	volt	230v, 50Hz				
Hava Debisi Air Flow	m <sup>3</sup> /sa	2600	2600	3500	2600	3500
Güç Power	W	170	170	210	170	210
Fan Çapı Fan Diameter	mm	350	350	400	350	400
Gürültü Seviyesi Noise Level	dBa	52	52	53	50	52
Genişlik (A) Width (A)	mm	885	885	885	782	782
Yükseklik (B) Height (B)	mm	450	490	530	2004	2004
Derinlik (C) Depth (C)	mm	760	760	760	562	562
Ağırlık Weight	kg	55	60	65	110	115
Isıtacağı Alan Heating Area	m <sup>2</sup>	60-120	80-150	150-225	80-150	150-225

\*Tablo değerleri yaklaşık değerlerdir. Ortamın durumuna göre (kapalı alan, izolasyon, hava akımı v.s.) değişiklik gösterebilir.

\*\*Tavsiye edilen emniyet mesafeleri, PANERA kontrolünde mekanın ihtiyaç ve konumuna göre değişebilir.

\*Table values are approximate. They might be variable according to atmospheric conditions like indoor space, isolation and airflow.

\*\* Recommended safe distance might be changed according to space conditions and location under the supervision of PANERA

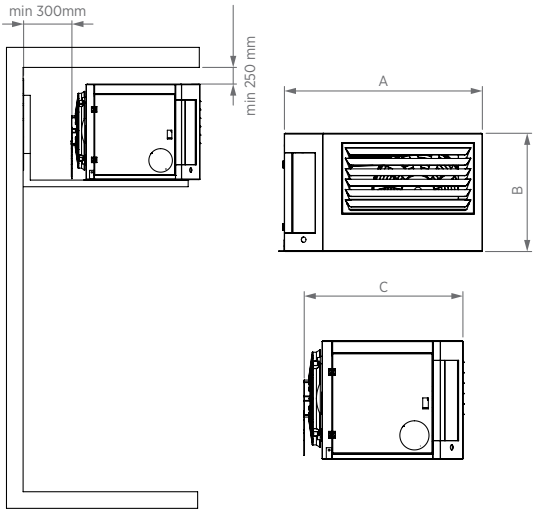

# SIROKKO

## 20-30-40

Sıcak Hava Üreteçleri  
Hot Air Generators



### Çift Kademeli Yakma Sistemi

Düşük veya yüksek kademeli yakma sistemi ile havanın sıcaklığına göre istenilen sıcaklık konforu rahatlıkla sağlanabilir.

### Two-stage burning system

With the low or high step burning system, the desired temperature comfort can be provided easily according to the temperature of the air.



### Uzaktan Kumanda

Opsiyonel olarak sunulan uzaktan kumanda ile rahat ve kolay kullanım.

### Remote Controller

Comfortable and easy operation with the optional remote control.



### Opsiyonel WiFi Kontrollü, Dijital ve Manuel Oda Termostatı Seçenekleri

Optional WiFi controlled, digital and manual room thermostat options



### Güvenlik

Honeywell ateşleme kartı ve gaz valfi takım olarak kullanılmıştır.

### Safety

Honeywell ignition card and gas valve are used as a set.

# SİROKKO 50-60-70

Sıcak Hava Üreteçleri

Hot Air Generators



- Yüksek verimlidirler
- Montaj ve işletmesi kolaydır
- Uzun ömürlüdür
- Elektronik ateşlemelidir
- Ortamı çok kısa zaman da rejime sokar
- Ekonomiktir
- Yatırım ve işletme maliyetleri kazan ve borulama vs. ihtiyacına göre düşüktür.

- High efficiency
- Ease to assemble and execute
- Long life
- Electronic ignition system
- Homogeneously heat distribution in a short time
- Economic
- Investment and operating costs are lower than heating system with boiler and tubing system

 Cihaz/Device : Sirokko

 Model/Model : 50 - 60 - 70

 Yakıt Tipi/Fuel Type : Doğalgaz, LPG/NLG, LPG



Sirokko 50



## Teknik Özellikler / Technical Features

Model/Model	Birim Unit	Sirokko 50	Sirokko 60	Sirokko 70
Nominal Isıl Güç Nominal Thermal Power	kW	47,5	57	66,5
Çıkış Gücü Output Power	kW	43	51,5	60
Doğalgaz Tüketimi Natural Gas Consumption	Nm <sup>3</sup> /sa	5	6	7,5
Gaz Bağlantısı Gas Connection	inch	1/2"	3/4"	3/4"
Giriş Basıncı Inlet Pressure	mbar	Doğalgaz (max: 55 / min: 20) - LPG (max: 55 / min: 30)		
Elektrik Besleme Power Supply	volt	230v, 50Hz		
Hava Debisi Air Flow	m <sup>3</sup> /sa	4800	5960	6800
Güç Power	W	250	276	276
Fan Çapı Fan Diameter	mm	450	350x2	400x2
Gürültü Seviyesi Noise Level	dB(A)	53	52	53
Genişlik (A) Width (A)	mm	950	1.185	1.185
Yükseklik (B) Height (B)	mm	885	885	885
Derinlik (C) Depth (C)	mm	810	850	850
Ağırlık Weight	kg	97	145	145
Isıtacağı Alan Heating Area	m <sup>2</sup>	200-400	250-500	325-650

\*Tablo değerleri yaklaşık değerlerdir. Ortamın durumuna göre (kapalı alan, izolasyon, hava akımı v.s.) değişiklik gösterebilir.

\*\*Tavsiye edilen emniyet mesafeleri, PANERA kontrolünde mekanın ihtiyacı ve konumuna göre değişebilir.

\*Table values are approximate. They might be variable according to atmospheric conditions like indoor space, isolation and airflow.

\*\* Recommended safe distance might be changed according to space conditions and location under the supervision of PANERA

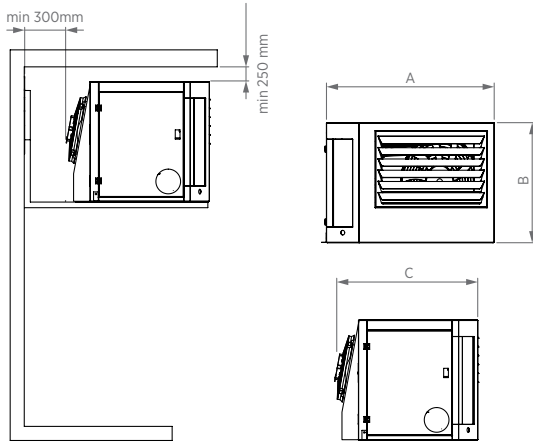

Sirokko 60-70

# SIROKKO

## 50-60-70

Sıcak Hava Üreteçleri  
Hot Air Generators



### Çift Kademeli Yakma Sistemi

Düşük veya yüksek kademeli yakma sistemi ile havanın sıcaklığına göre istenilen sıcaklık konforu rahatlıkla sağlanabilir.

### Two-stage burning system

With the low or high step burning system, the desired temperature comfort can be provided easily according to the temperature of the air.



### Uzaktan Kumanda

Opsiyonel olarak sunulan uzaktan kumanda ile rahat ve kolay kullanım.

### Remote Controller

Comfortable and easy operation with the optional remote control.



### Opsiyonel WiFi Kontrollü, Dijital ve Manuel Oda Termostatı Seçenekleri

Optional WiFi controlled, digital and manual room thermostat options



### Güvenlik

Honeywell ateşleme kartı ve gaz valfi takım olarak kullanılmıştır.

### Safety

Honeywell ignition card and gas valve are used as a set.





# SIROKKO Farm

Sıcak Hava Üretici

■ Hot Air Generators

Sirokko Farm ısıtma ve yakma verimi yüksek, kanal tipi kullanıma uygun, doğal gaz ve propan ile çalışabilen sıcak hava üreticidir. Çiftlik ve kümes binalarının ısıtılarak yoğun üreme sağması amacıyla tasarlanmıştır. Basınçlı fanı sayesinde kanal tipi kullanıma uygun olup, ısıtılacak ortamdan bağımsız olarak kullanılabilir. Ayrıca özel çift yönlü damperli hava kanalları sayesinde ortama istenilen miktarda sıcak ve temiz hava sağlayarak gereksiz ısıtma maliyetinin önüne geçer.

Sirokko Farm is a hot air generator with high heating and combustion efficiency, suitable for duct type use, operating with natural gas and propane. It is designed to provide intensive breeding by heating farm and poultry buildings. Thanks to its pressurized fan, it is suitable for duct-type use and can be used independently of the environment to be heated. In addition, it prevents unnecessary heating costs by providing the desired amount of hot and clean air to the environment thanks to its special bidirectional damper air ducts.

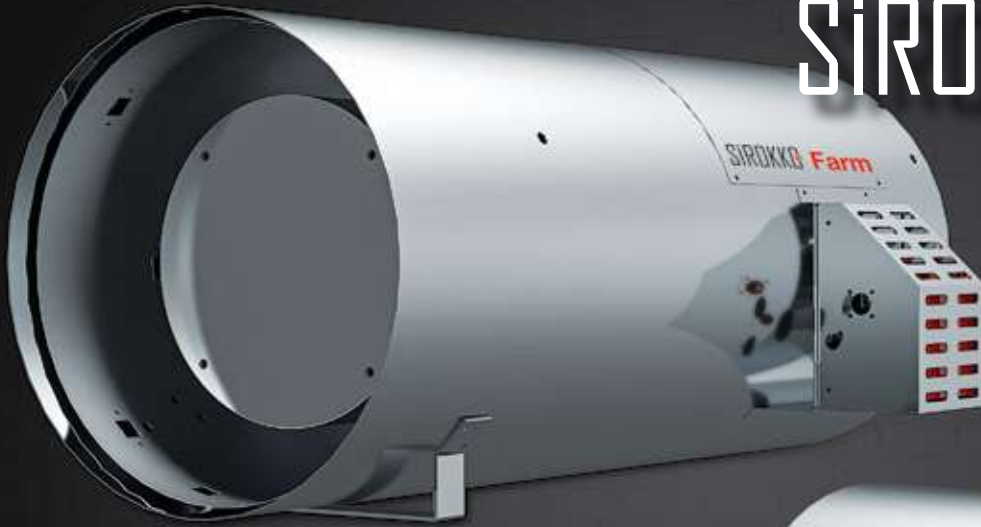

-  **Cihaz/Device** : Sirokko Farm
-  **Model/Model** : Sirokko KM 80
-  **Yakıt Tipi/Fuel Type**: Doğalgaz, LPG/NLG, LPG



# SIROKKO Farm

Sıcak Hava Üretici

■ Hot Air Generators

-  **Cihaz/Device** : Sirokko Farm
-  **Model/Model** : Sirokko JET 80
-  **Yakıt Tipi/Fuel Type**: Doğalgaz, LPG/NLG, LPG



## Teknik Özellikler / Technical Features

Model/Model	Sirokko Farm	Sirokko KM 80	Sirokko JET 80
Nominal Isıl Güç Nominal Thermal Power	kW	82	82
Verim Efficiency	%	89	89
Hava Debisi Air Flow	m <sup>3</sup>	2.000	5.500
Üfleme Mesafesi Blowing Distance	m	30	30
Elektrik Besleme Power Supply	volt	220-240v 50 Hz	220-240v 50 Hz
Genişlik (A) Width (A)	mm	760	1.050
Yükseklik (B) Height (B)	mm	750	450
Derinlik (C) Depth (C)	mm	530	550

\*Tablo değerleri yaklaşık değerlerdir. Ortamın durumuna göre (kapalı alan, izolasyon, hava akımı v.s.) değişiklik gösterebilir.

\*\*Tavsiye edilen emniyet mesafeleri, PANERA kontrolünde mekanın ihtiyaç ve konumuna göre değişebilir.

\*Table values are approximate. They might be variable according to atmospheric conditions like indoor space, isolation and airflow.

\*\* Recommended safe distance might be changed according to space conditions and location under the supervision of PANERA

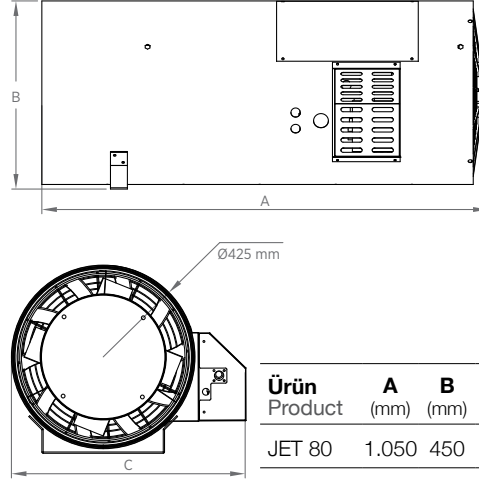
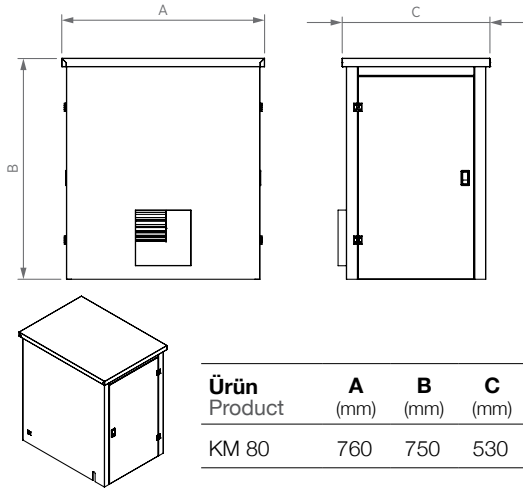

# SIROKKO

## Farm

Sıcak  
Hava Üreteçleri



### Modüler Hava Giriş Kanalı

İstenilen oranda temiz hava girişi sağlayan kolay ayarlanabilir hava kanalı.

### Modular Air Intake Duct

Easily adjustable air duct providing clean air intake at the desired rate.



### Modüler Hava Çıkış Kanalı

Kanal tipi ve kanalsız kullanıma uygun modüler çıkış kanalı.

### Modular Air Outlet Duct

Modular output channel suitable for duct type and ductless use.



### Opsiyonel Dijital ve Manuel Oda Termostatı Seçenekleri

Optional Digital and manual room thermostat options



### Güvenlik

**Honeywell** ateşleme kartı ve gaz valfi takım olarak kullanılmıştır.

### Safety

**Honeywell** ignition card and gas valve are used as a set.



# SIROKKO AirWall

Hava Perde Sistemleri

■ Air Curtain

- Araç Muayene İstasyonları
- Fabrikalar
- Depolar

- Vehicle Inspection Stations
- Factories
- Warehouses

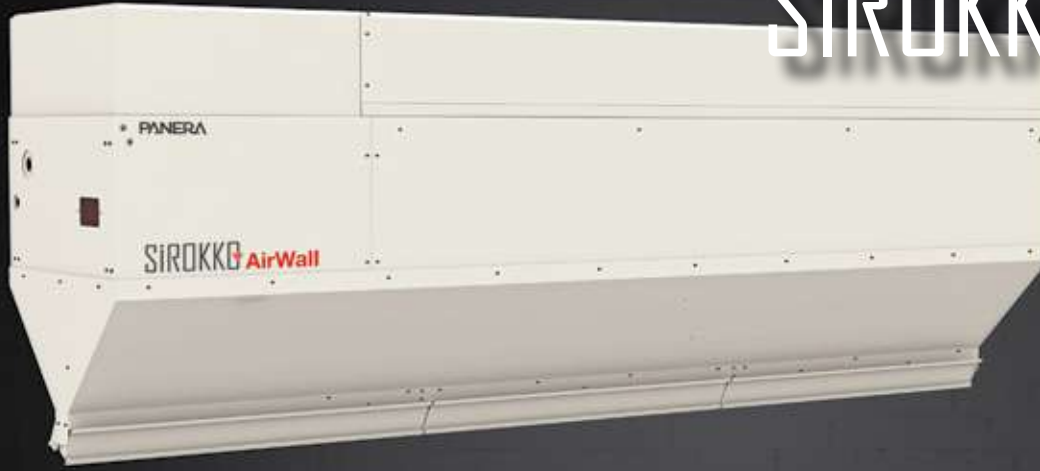

## Avantajları / Advantages

- Hava perdeleri açık kapılardan hava transferini azaltarak enerji maliyetlerini düşürür.
- Hava perdeleri yaz veya kış aylarında hava transferini engelleyerek konforu artırır.
- Air curtains reduce energy costs by reducing air transfer through open doors.
- Air curtains increase comfort by preventing air transfer in summer or winter.

İmalathaneler ve satış alanlarının enerji kayıpları açısından en yoğun bölgeleri dış kapılarıdır. Kışın ısıtılmış hava yaz aylarında ise yüksek maliyetli soğutulmuş hava bu açıklıklardan kaybedilir. Kapılar ne kadar büyüse iç ve dış hava sıcaklıkları arasındaki kontrol edilemeyen değişimler nedeni ile masraflar da artar. Ayrıca kapılar arasında hava akımı olasılığı da artar. Hava perdeleri yardımı ile ortam ısısı kontrol altında tutulur. Bununla birlikte enerji maliyetleri düşer ve çalışma koşulları iyileşir.

The most intense areas in terms of energy losses of workshops and sales areas are their outer doors. Heated air in the winter and the costly chilled air in the summer are lost through these openings. The larger the doors, the higher the costs due to uncontrollable changes between indoor and outdoor temperatures. It also increases the possibility of airflow between the doors. The ambient temperature is kept under control with the help of air curtains. With this, energy costs decrease and working conditions improve.

 Cihaz/Device : Sirokko

 Model/Model : Air Wall

 Yakıt Tipi/Fuel Type : Doğalgaz, LPG/NLG, LPG

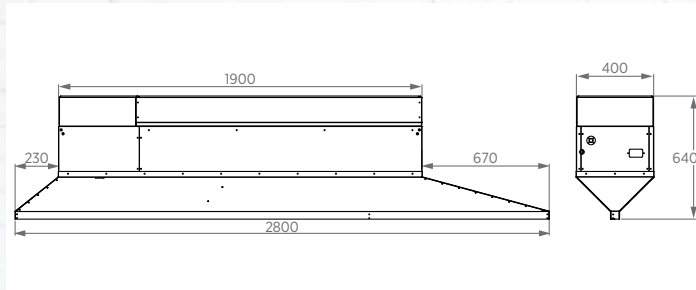

## Teknik Özellikler / Technical Features

Model/Model	1. Kademe Gücü 1 <sup>st</sup> Step Power	Doğalgaz Tüketimi Natural Gas Consumption	Doğalgaz Basıncı Natural Gas Pressure	Hava Debisi Air Flow
AIR WALL 20	21,7 kW	2,30 m <sup>3</sup>	20-55 mbar	1400x3

### Güvenlik

**Honeywell** ateşleme kartı ve gaz valfi takım olarak kullanılmıştır.

### Safety

**Honeywell** ignition card and gas valve are used as a set.



Air Wall hava perdesi kullanılmayan ortamın ısı dengesi  
Heat balance of the environment where Air Wall air curtain is not used

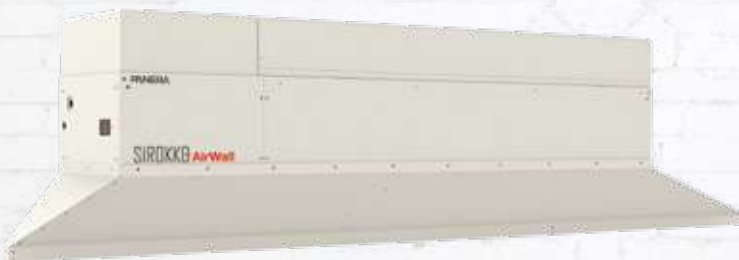

### Uzaktan Kumanda

Dahili olarak sunulan uzaktan kumanda ile rahat ve kolay kullanım.

### Remote Controller

Built-in remote control for convenient and easy operation.



Air Wall hava perdesi kullanılan ortamın ısı dengesi  
Heat balance of the environment where Air Wall air curtain is used

# PANERA

[www.panera.com.tr](http://www.panera.com.tr)

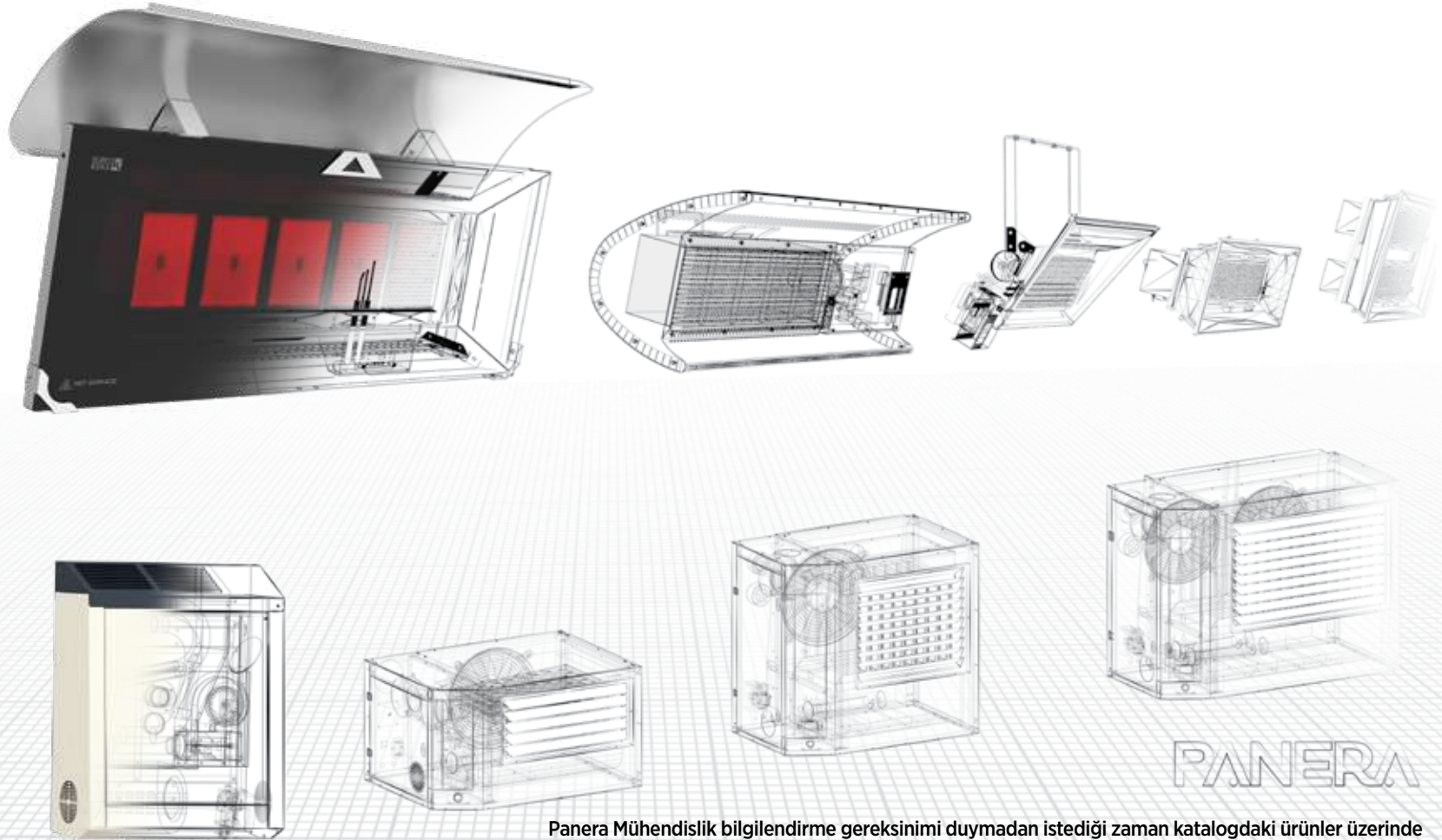

PANERA

Panera Mühendislik bilgilendirme gereksinimi duymadan istediği zaman katalogdaki ürünler üzerinde değişiklik ve düzeltme yapma hakkını saklı tutar.

PANERA Engineering reserves innovation and revision rights on products specified in the catalogue without notifying them.

# PANERA



## Panera Mühendislik A.Ş.

Fevzi Çakmak Mahallesi 10758 Sk. No: 9/D  
Karatay / Konya / TÜRKİYE

+90 332 346 1234  
+90 332 346 0123  
info@panera.com.tr

## Panera İstanbul Satış & Showroom

Cevizli Mh. Hızır Reis Sk. No:10/B  
Maltepe / İstanbul / TÜRKİYE

+90 216 457 01 57  
+90 533 592 01 02  
bilgi@panera.com.tr



Bayi



 gufo  SIROKKO  TRADYANT



www.panera.com.tr